

CATALOGO GENERAL  
GENERAL CATALOGUE

CATALOGO GENERALE

GENERAL CATALOGUE

GENERAL CATALOGUE



CATALOGO GENERALE

GENERAL CATALOGUE

TYRE  
CHANGERS



WHEEL  
BALANCERS



WHEEL  
ALIGNMENT



PROADAS  
TECHNOLOGY



LIFTS



TESTING  
EQUIPMENT



MISCELLANEOUS





# Automotive Service Equipment



GP 20 ATV BIKE

AS 905



AS 922



AS 924  
AS 924A



AS 933



BAKHEET  
FIX  
CONCEPT  
INVEST. TRAIN. MAINTAIN



AS 934

AS 943



AS 944



AS 946



AQUILA  
TWISTER



[www.facebook.com/MONDOLFOFERROfficial](https://www.facebook.com/MONDOLFOFERROfficial)



<http://www.youtube.com/user/MondolfoFerro>



<https://www.instagram.com/mondolfoferro>

NEXION SPA  
info@mondolfoferro.it  
www.mondolfoferro.it



# AQUILA



GP 20 ATV	5"-23"	-	-	1000 mm	0,75 Hp 1 ph 0,55 Hp 3 ph	-	10 bar	-
AS 905	13"-25"	11"-22"	12"	980 mm	0,55 kW	8,5 rpm	10 bar	320 mm
AS 922	13"-25"	10"-22"	12,5"	1000 mm	0,75 kW	8,5 rpm	8-10 bar	320 mm
AS 924 - AS 924A	13"-26"	10"-24"	14"	1100 mm	0,75 kW	8 rpm 13 rpm (2V)	8-10 bar	370 mm
AS 933 - AS 933 TI	13"-23"	10"-20"	12"	1040 mm	0,75 kW	8 rpm 6-15 rpm (2V)	10 bar	320 mm
AS 934 - AS 934 TI	13"-23"	10"-20"	12"	1040 mm	0,75 kW	8 rpm 6-15 rpm (2V)	10 bar	320 mm
AS 943 - AS 943 TI	13"-25"	10"-22"	14"	1040 mm	0,75 kW	8 rpm 6-15 rpm (2V)	10 bar	410 mm
AS 944 - AS 944 TI	13"-26"	10"-24"	14"	1040 mm	0,75 kW	8 rpm 6-15 rpm (2V)	10 bar	410 mm
AS 946 - AS 946 TI	13"-28"	10"-26"	14"	1060 mm	0,75 kW	8 rpm 6-15 rpm (2V)	10 bar	410 mm
AQUILA TWISTER	13"-26"	10"-24"	15"	1035 mm	0,75 kW	8 rpm 6-15 rpm (2V)	8-10 bar	410 mm



RPX

**BAKHEET  
FIX  
CONCEPT**  
INVEST. TRAIN. MAINTAIN

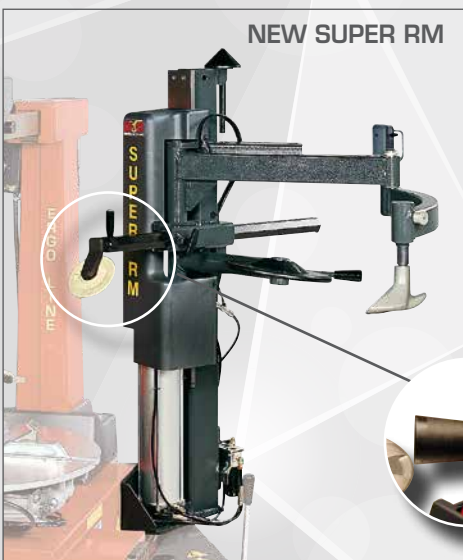

NEW SUPER RM



SUPER RM 2  
EAGLE



SRM 300



SUPER RM MINI





# AQUILA



AS 944 LL	13"-26"	10"-24"	14"	1040 mm	0,75 kW	8 rpm 6-15 rpm (2V)	10 bar	410 mm
RAPTOR	12"-28"	-	15"	42"- 1080 mm	0,75 kW	6-15 rpm (2V)	10 bar	-
AUDAX - AUDAX M	12"-30"	-	16"	47"- 1200 mm	0,75 kW	7-18 rpm (2V)	10 bar	-
RAPAX	13"-28"	-	15"	47"- 1200 mm	0,75 kW	7-18 rpm (2V)	8-10 bar	-
TORNADO	13"-32"	-	16"	47"- 1200 mm	0,8 kW	7-18 rpm (2V)	10 bar	-



**MOBILE SERVICE**  
AUDAX M



AS 944 LL

AUDAX

RAPTOR

RAPAX

TORNADO

**WITHOUT LEVER**



[www.facebook.com/MONDOLFOFERROfficial](http://www.facebook.com/MONDOLFOFERROfficial)



<http://www.youtube.com/user/MondolfoFerro>



<https://www.instagram.com/mondolfoferro>

NEXION SPA  
info@mondolfoferro.it  
www.mondolfoferro.it





TB 120

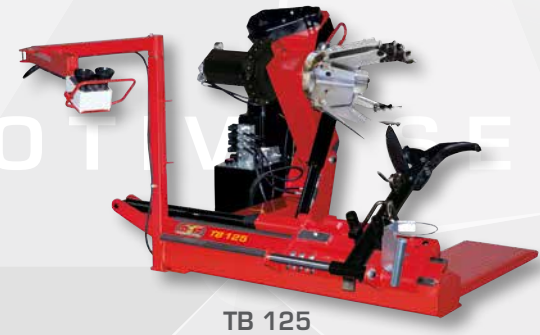

TB 125



TB 128



TBE 155



TBE 155 S



TBE 156

PRO



TBE 160 MATIC **WITHOUT LEVER**  
& TBE 160 TERRA



TBE 60 **TERRA**



TB 120	14"-26"	695 mm	1400 mm	700 kg	14000 N
TB 125	14"-26"	780 mm	1600 mm	700 kg	17000 N
TB 128 N - DELUXE - SUPER	14"-26"	780 mm	1500 mm	700 kg	20000 N
TBE 155	14"-56"	1065 mm	2300 mm	1000 kg	27000 N
TBE 155 S	14"-56"	1300 mm	2200 mm	1700 kg	29000 N
TBE 156 PRO N - DELUXE - SUPER	14"-56"	1220 mm	2450 mm	1700 kg	30000 N
TBE 160 MATIC <b>WITHOUT LEVER</b>	14"-60"	1600 mm	2700 mm	2000 kg	37000 N
TBE 160 TERRA	14"-60"	1600 mm	2700 mm	2000 kg	37000 N
TBE 60 TERRA	14"-60"	1800 mm	3000 mm	3000 kg	45000 N
TB 123 MOBILE	13"-26"	520-960 mm	1380 mm	350 kg	13000 N
TB 124 MOBILE	14"-26"	520-960 mm	1350 mm	500 kg	15000 N

## MOBILE SERVICE



TB123 MOBILE



TB124 MOBILE



[www.facebook.com/MONDOLFOFERROofficial](https://www.facebook.com/MONDOLFOFERROofficial)



<https://www.youtube.com/user/MondolfoFerro>



<https://www.instagram.com/mondolfoferro>

NEXION SPA  
info@mondolfoferro.it  
www.mondolfoferro.it



Equilibratrici - Wheel balancers - Equibreuses - Auswuchtmaschinen - Equilibradoras - Máquinas de equilibrar - Балансир



MT 3100UP - MT 3200UP  
MT 3200UP PLUS  
MT 3200UP C PLUS  
EASY ALU



MT 3600UP - MT 3600UP C  
EASY ALU



MT 3350UP - MT 3350UP C  
LASER



MT 3650UP - MT 3650UP C  
LASER  
\*Touchscreen version available



MT 3500UP - MT 3500UP C  
LASER & SONAR



MT 3800UP  
MT 3800UP C  
LASER & SONAR



MT 3900UP C



MT 4000UP  
DIAGNOSTIC



TOUCHSCREEN  
& CONTACTLESS



WL R  
MANUAL



80 kg

CAR



80 kg



WL Ø  
AUTOMATIC

MT 3100UP - MT 3200UP - MT 3600UP	1gr - 1/10oz	10"-28"	1,5"-20"	1118 mm	85 kg
MT 3350UP - MT 3650UP	1gr - 1/10oz	10"-28"	1,5"-20"	1118 mm	85 kg
MT 3500UP - MT 3800UP	1gr - 1/10oz	10"-28"	1,5"-20"	1118 mm	85 kg
MT 3900UP - MT 4000UP	1gr - 1/10oz	10"-32"	1,5"-20"	1118 mm	85 kg



[www.facebook.com/MONDOLFOFERROofficial](https://www.facebook.com/MONDOLFOFERROofficial)



<http://www.youtube.com/user/MondolfoFerro>



<https://www.instagram.com/mondolfoferro>

NEXION SPA  
info@mondolfoferro.it  
www.mondolfoferro.it





MT 6310  
TRUCK



Portable display



MT 6350  
TRUCK



MT 2450  
TRUCK



MT 2650  
TRUCK



INVEST. TRAIN. MAINTAIN

TRUCK

MOBILE SERVICE

MT 3000UP AUTOSELECT 4 versions available:



VAN Version



MT3000UP STANDARD & TILT VERSION



WORKBENCH Version

MT 6350 TRUCK	1gr - 1/10oz	8"-28" CAR & TRUCK	1,5"-25" CAR & TRUCK	1320 mm	150 kg
MT 6310 TRUCK	5gr - 1/4 oz	10"-30" CAR & TRUCK	1,5"-20" CAR & TRUCK	1320 mm	250 kg
MT 2450	1gr - 1/10oz	7"-30" car 12"-30" truck	1,5"-22" car 4"-22" truck	1220 mm	300 kg
MT 2650	1gr - 1/10oz	7"-30" car 12"-30" truck	1,5"-22" car 4"-22" truck	1220 mm	200 kg
MT 3000 UP AUTOSELECT	1gr - 1/10oz	10"-28"	1,5"-20"	1118 mm	85 kg



[www.facebook.com/MONDOLFOFERROofficial](http://www.facebook.com/MONDOLFOFERROofficial)



<http://www.youtube.com/user/MondolfoFerro>



<https://www.instagram.com/mondolfoferro>

NEXION SPA  
info@mondolfoferro.it  
www.mondolfoferro.it





TRIGON 648 PRO



TRIGON 728 PLATINUM S



TRIGON 725 PRO  
TRIGON 725 PRO TRUCK



TRIGON  
TOP VISION



TRIGON  
SUPER NOVO



Portable version available



Portable version available



TRIGON 648  
PRO SMART



TRIGON NOVO

VERSION:

NOVO  
CM W



TRIGON  
ROBOTEC  
Only for the  
italian market



TRIGON THRU VISION

TRIGON



648 PRO	✓	✓	✓		0,01°	84.000 Vehicles	19"-27"
648 PRO SMART	✓	✓	✓		0,01°	84.000 Vehicles	19"-27"
725 PRO	✓	✓	✓		0,01°	84.000 Vehicles	19"-27"
728 PLATINUM S	✓	✓	✓		0,01°	84.000 Vehicles	19"-27"
NOVO		✓		✓	0,01°	84.000 Vehicles	19"-27"
SUPER NOVO		✓		✓	0,01°	84.000 Vehicles	19"-32"
TOP VISION		✓		✓	0,01°	84.000 Vehicles	19"-32"
3D THRU VISION		✓		✓	0,01°	84.000 Vehicles	19"-27"
ROBOTEC		✓		✓	0,01°	84.000 Vehicles	19"-32"



\*OPTIONAL

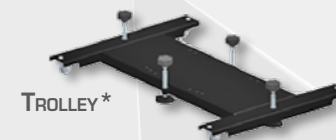

TROLLEY\*

COMPATIBLE WITH TRIGON NOVO, TRIGON  
SUPER NOVO AND TRIGON TOP VISION



NEXREMOTE



[www.facebook.com/MONDOLFOFERROfficial](http://www.facebook.com/MONDOLFOFERROfficial)



<http://www.youtube.com/user/MondolfoFerro>



<https://www.instagram.com/mondolfoferro>

NEXION SPA  
info@mondolfoferro.it  
www.mondolfoferro.it





**PRE-CHECK**

**QUICKVISION 3.5**



Tecnologia *Contactless*

BAKHEET  
FIX  
CONCEPT  
INVEST. TRAIN. MAINTAIN

**SMART REMOTE KIT**



OPTIONAL

Available with:

- LAUNCHER
- LAUNCHER & Auto QR

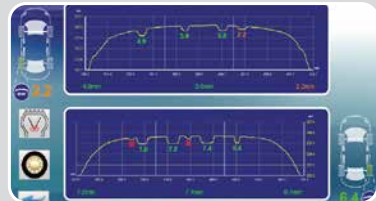

**PROFILE READER**

**TRIGON**

Dynatech Vehicle Dynamics Quick Check

Precheck dinamico al passaggio per la verifica rapida della geometria del veicolo per auto e trasporto leggero



Dynamic pre-check while passing through for a quick check of vehicle geometry for cars and light duty vehicles

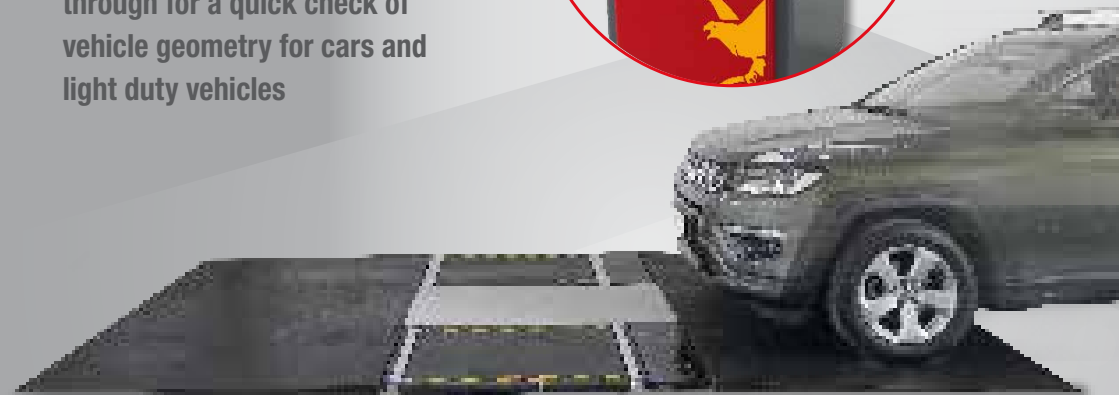

[www.facebook.com/MONDOLFOFERROfficial](https://www.facebook.com/MONDOLFOFERROfficial)



<http://www.youtube.com/user/MondolfoFerro>



<https://www.instagram.com/mondolfoferro>

NEXION SPA  
info@mondolfoferro.it  
www.mondolfoferro.it





**PROADAS RS DIGITAL**



**Soluzione indipendente equipaggiata con monitor 75" e sensori CCD per calibrare sensori ADAS frontali: Telecamera, Radar e Lidar.**  
Standalone version equipped with a 75" monitor and CCD sensor heads to calibrate frontal ADAS sensors: Camera, Radar and Lidar.

**PROADAS START DIGITAL**



**Soluzione indipendente equipaggiata con monitor 75" e puntatori laser per calibrare sensori ADAS frontali: Telecamera, Radar e Lidar.**  
Standalone version equipped with a 75" monitor and laser pointers to calibrate frontal ADAS sensors: Camera, Radar and Lidar.

**PROADAS TS DIGITAL**



**Soluzione equipaggiata con monitor 75" compatibile con assetto TRIGON 728\*/725\*/648 per calibrare sensori ADAS frontali: Telecamera, Radar e Lidar.**  
Version equipped with a 75" monitor compatible with TRIGON 728\*/725\*/648 wheel aligners to calibrate frontal ADAS sensors: Camera, Radar and Lidar.  
\*Produzione / production : 01.2016

**PROADAS TS-3D DIGITAL**



**Soluzione equipaggiata con monitor 75" compatibile con assetto 3D TRIGON Super Novo e TRIGON TOP Vision per calibrare sensori ADAS frontali: Telecamera, Radar e Lidar.**  
TRIGON Super Novo 3D and TRIGON TOP Vision wheel alignment compatible version, equipped with a 75" monitor to calibrate frontal ADAS sensors: Camera, Radar and Lidar.



**PROADAS RS V1**



**Soluzione indipendente equipaggiata con sensori CCD per calibrare sensori ADAS frontali: Telecamera, Radar e Lidar.**  
Standalone version equipped with CCD sensor heads to calibrate frontal ADAS sensors: Camera, Radar and Lidar.

**PROADAS START V1**



**Soluzione indipendente equipaggiata con puntatori laser per calibrare sensori ADAS frontali: telecamera, radar e Lidar.**  
Standalone version equipped with laser pointers to calibrate frontal ADAS sensors: Camera, Radar and Lidar.

**PROADAS TS**



**Soluzione compatibile con assetto TRIGON 728\*/725\*/648 per calibrare sensori ADAS frontali: telecamera, radar e Lidar.**  
Version compatible with TRIGON 728\*/725\*/648 wheel aligners to calibrate frontal ADAS sensors: Camera, Radar and Lidar.  
\*Produzione / production : 01.2016

**PROADAS TS-3D**



**Soluzione compatibile con assetto 3D TRIGON Super Novo e TRIGON TOP Vision per calibrare sensori ADAS frontali: telecamera, radar e Lidar.**  
TRIGON Super Novo 3D e TRIGON TOP Vision wheel alignment compatible version to calibrate frontal ADAS sensors: Camera, Radar and Lidar.





Modello Model	Modalità lavoro Way of working	Tecnologia Technology									
Proadas RS*			✓	✓	OPTIONAL	✓			✓		✓
Proadas START*			✓			✓			✓		✓
Proadas TS*			✓			✓			✓		✓
Proadas TS-3D*			✓			 INVEST. TRAIN. MAINTAIN			✓		✓
SCE 310*			✓						✓		✓
SCE 700*			✓				✓	✓		✓	

Proadas RS	Proadas START	SCE 310	SCE 700	Con assetto 3D 3D wheel aligners	Con assetto CCD CCD wheel aligners	Telecamera 3D 3D camera	Testine CCD CCD sensors heads	Puntatore Laser Laser pointers
Controllo pos. tempo reale Real time positioning control	Precheck assetto Precheck wheel alignment	Manutenzione assetto Wheel alignment service	Telecamera frontale Front camera	Telecamera posteriore Rear camera	Telecamera 360° 360° camera	Radar frontale Front radar	Radar BSD BSD radar	LIDAR frontale Front LIDAR

# iONE CRUISER

The turning point  
for the vehicle diagnosis



IONEPLATFORM.COM

Dispositivo per la diagnosi di nuova generazione, progettato per lavorare con tutti i tipi di veicoli e protocolli di comunicazione con le diverse ECU.

**iONE TECHIDATA** NO NEED FOR AN INTERNET BROWSER

New generation diagnostic device designed to work with all types of vehicle and communication protocols with the various ECUs.



[www.facebook.com/MONDOLFOFERROfficial](https://www.facebook.com/MONDOLFOFERROfficial)



<http://www.youtube.com/user/MondolfoFerro>



<https://www.instagram.com/mondolfoferro>

NEXION SPA  
info@mondolfoferro.it  
www.mondolfoferro.it





## 2 COLUMN



P 235



P 232N - P 232N BC - P 232N EC  
P 240N EC - P 240 EX - P 250 EC



P 230 BC



SERIES PI 232

## ELECTRO MECHANICAL



## TITAN



P 235	3500 kg	90 mm	1945 mm	2500 mm
P 230 BC	3000 kg	99 mm	1945 mm	2560 mm
P 232N - P 232N BC	3200 kg	120 mm	1950 mm	2570 mm
P 232N EC	3200 kg	85 mm	1915 mm	2570 mm
P 240N EC	4000 kg	85 mm	1925 mm	2755 mm
P 240 EX	4000 kg	70 mm	1890 mm	2700 mm
P 250 EC	5000 kg	105 mm	2005 mm	2800 mm
PI 232	3200 kg	99 mm	1980 mm	2600 mm
PI 232 BC	3200 kg	99 mm	2030 mm	2600 mm
PI 240 N	4000 kg	80 mm	1940 mm	2680 mm
PI 240 E	4000 kg	100 mm	1930 mm	2680 mm
PI 255 VXL	5500 kg	100/255 mm	2055 mm	3100 mm
PI 250	5000 kg	95 mm	2050 mm	3100 mm



SERIES PI 250



SERIES PI 240 N & SERIES PI 240 E



PI 255 VXL

## ELECTRO HYDRAULIC





X 1300 - X 1350



X 3000\* - X 3500\* - X 4000\*



X 2035 T\* - X 2040 T\*

**BAKHEET  
FIX  
CONCEPT**  
INVEST. TRAIN. MAINTAIN.

**NEW**

\* Nuovi modelli "ECO" disponibili, stesse dimensioni, ma doppio sistema Master-Slave e nessuna elettronica sul lato forbice.  
New "ECO" models available, same dimensions, but double Master-Slave system and no electronics on scissor side.

**TITAN**



X 1300	3000 kg	970 mm	110 mm	2050 - 2100 mm
X 1350	3500 kg	970 mm	110 mm	2050 - 2100 mm
X 2035 T	3200 kg	2000 mm	250 mm	2110 mm
X 2040 T	4000 kg	2000 mm	250 mm	2110 mm
X 3000	3000 kg	1900-2000 mm	115 mm	1550-2240 mm
X 3500	3500 kg	1900-2000 mm	115 mm	1550-2240 mm
X 4000	4000 kg	1900-2000 mm	115 mm	1550-2240 mm
X 571 - X 573	5000 kg	2105 mm	255 mm	5200 mm
SL 25	2500 kg	500 mm	115 mm	1360 mm

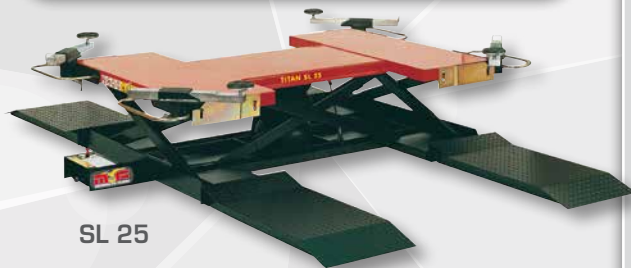

SL 25

**CRICK  
MC**



MC 002 2 t  
MC 118 16 t  
MC 240 MC 240 P 28 t  
MC 330 60 t  
MC 440 40 t



[www.facebook.com/MONDOLFOFERROofficial](http://www.facebook.com/MONDOLFOFERROofficial)



<http://www.youtube.com/user/MondolfoFerro>



<https://www.instagram.com/mondolfoferro>

NEXION SPA  
info@mondolfoferro.it  
www.mondolfoferro.it





## 4 COLUMN

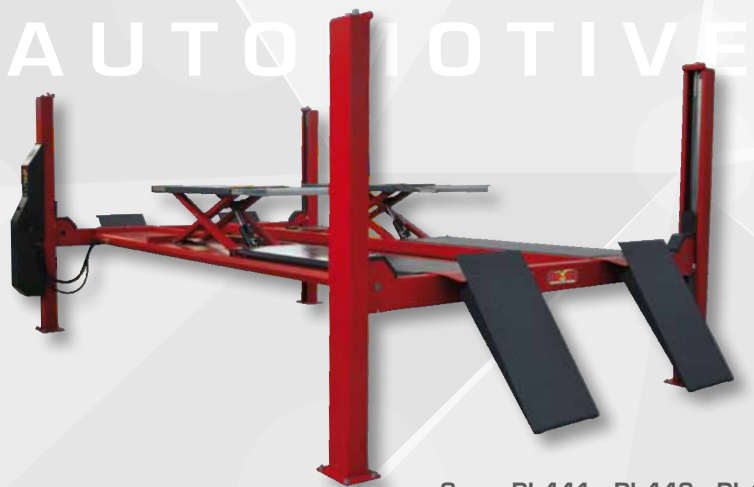

SERIES PI 441 - PI 443 - PI 451 - PI 453

## TITAN



PI 441 B	4000 kg	1960 mm	126 mm	4870 mm
PI 443 B	4000 kg	1960 mm	126 mm	4870 mm
PI 443 W BL	4000 kg	1960 mm	180 mm	5100 mm
PI 451 W	5000 kg	1960 mm	180 mm	5100 mm
PI 453 W	5000 kg	1960 mm	180 mm	5100 mm
PI 453 LT	5000 kg	1960 mm	180 mm	5205 mm

SERIES X 571 - X 573 - X 461 - X 463



SERIES X 593 T - X 693 T

## TITAN



X 593 T	5000 kg	2020 mm	180 mm	5200 mm
X 693 T	6500 kg	2180 mm	280 mm	5400 mm
X 571 - X 573	5000 kg	2105 mm	255 mm	5200 mm
X 461 - X 463	4300 kg	2090 mm	240 mm	4650 mm





7.5 t  
MAX  
5.5 t  
MAX  
**TRUCK**



ZEUS

4 colonne / 4-column set  
ZEUS -4

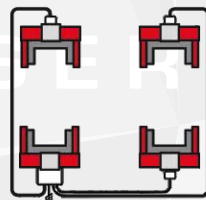

6 colonne / 6-column set  
ZEUS -4 + ZEUS -2

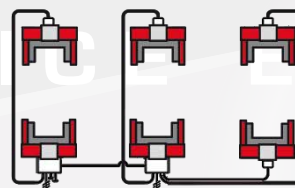

8 colonne / 8-column set  
ZEUS -4 + ZEUS -4

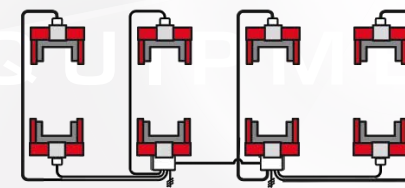

MAGNUM	10 ÷ 40 t	1900 mm	210 mm	5800 ÷ 18750 mm
M 600	600 kg	1200 mm	155 mm	2260 mm

**BAKHEET  
FIX  
CONCEPT**  
INVEST. TRAIN. MAINTAIN

**BIKE**



M600

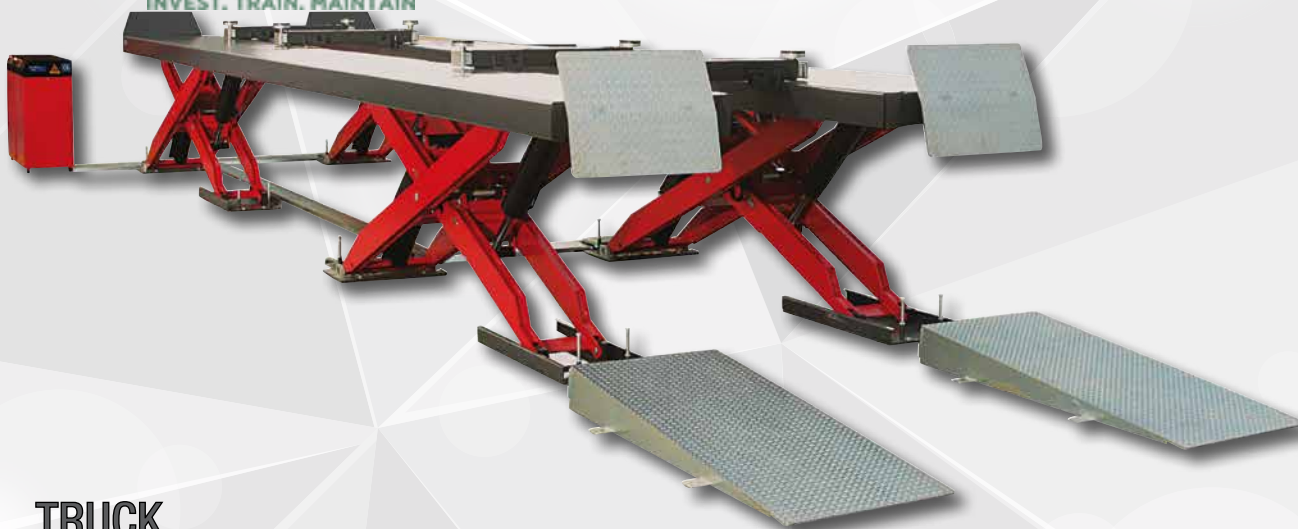

**TRUCK**

SERIES MAGNUM



[www.facebook.com/MONDOLFOFERROofficial](http://www.facebook.com/MONDOLFOFERROofficial)



<http://www.youtube.com/user/MondolfoFerro>



<https://www.instagram.com/mondolfoferro>

NEXION SPA  
info@mondolfoferro.it  
www.mondolfoferro.it





## Sollevatori Interrati • In-ground Lifts

AUTOMOTIVE SERVICE EQUIPMENT



TITAN IL 3500.2



TITAN P 35.2 IL



BAKHEET  
TITAN P 55.2 IL  
CONCEPT  
INVEST. TRAIN. MAINTAIN

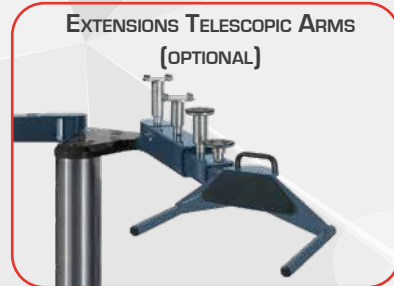

CYLINDER  
DIAMETER



	Weight	Platform Diameter	Cylinder Diameter	Time
TITAN IL 3500.2	3500 kg	2015 mm	2 x 123 mm	30 sec
TITAN P 35.2 IL	3500 kg	2020 - 2085 mm	2 x 123 mm	30 sec
PIDC 55.2	5500 kg	1955 - 2055 mm	2 x 213 mm	45 sec





**MCTC Net2**



23\*34\*22,5 mm

**OPA 820 - 840**

Strumento per la misura dell'opacità dei motori Diesel sugli autoveicoli e veicoli industriali  
Opacimeter for diesel engines in passenger car and industrial vehicles.

**GAS 810 - 830**

Analizzatore gas di scarico per motori a benzina, metano e GPL  
Exhaust gas analyser for petrol, methane and LPG engines.



0-6 kN



**BRM S-FLAT BOX**

**MCTC Net2**

Banco prova freni a rulli universale  
Universal car brake tester



**MCTC Net2**

**NT CAM/M**

Sistema di riconoscimento automatico targa  
Automatic LICENSE PLATE recognition system



**PFT - CAM**

**MCTC Net2**

Only for Italian Market

Centrafari a Telecamera  
Camera Headlight tester



<b>BRM 4.8W MCTC</b>	2*4,8 kW	3000 kg	5 km/h
<b>BRM S-FLAT BOX</b>	2*4,0 kW	2500 kg	5 km/h
<b>DINA UP BRAKE</b>	1,5 kW	2500 kg	7/10 km/h

**PD 25-45**

Prova giochi idraulico

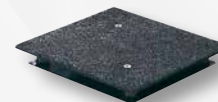
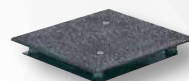

0-6 kN



17" - 19"



**BRM 4.8W MCTC**

**MCTC Net2**

Only for Italian Market

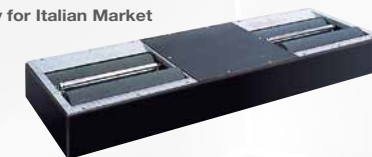

0-6 kN



**DINA UP BRAKE**

**MCTC Net2**

Banco prova freni a piastre universale  
Universal plate brake tester



[www.facebook.com/MONDOLFOFERROofficial](http://www.facebook.com/MONDOLFOFERROofficial)



<http://www.youtube.com/user/MondolfoFerro>



<https://www.instagram.com/mondolfoferro>

NEXION SPA  
info@mondolfoferro.it  
www.mondolfoferro.it





VORTEX 850



12" - 33"
6" - 14"
1475*1015*1305 mm
65 kg
8 - 10 bar

PARTNER70



TPM-02



IMPACT WRENCHES / AVVITATORI



AV 102

FOR CARS, VANS, SUV AND MOTORCYCLES



AV 150

FOR EARTH MOVEMENT AND FARMING VEHICLES



AV 201

FOR TRUCKS AND BUSES

NITRONIC

300	3 Nm³/h	1330*600*650 mm	85 kg	8 - 10 bar
500	5 Nm³/h	1330*600*650 mm	87 kg	8 - 10 bar
1800	18 Nm³/h	1430*700*650 mm	52 kg	10 - 12 bar



AIR CONDITIONING RECHARGE / RICARICA ARIA CONDIZIONATA

A/C 1100  
R-134A

A/C 1105  
R-1234yf

A/C 1600  
R-134A

A/C 1605  
R-1234yf

Completamente automatica  
Completely automatic



Gestione veicoli ibridi / Management of hybrid vehicles - Recupero Refrigerante / Refrigerant recovery

INFLATION CAGE / GABBIE DI GONFIAGGIO



TBR ALCATRAZ



TBR 1100



OTR 2000



MAXI SAFE

	TBR ALCATRAZ	TBR 1100	OTR 2000	MAXI SAFE
	550 mm 21,6"	600 mm 23,6"	850 mm 33,5"	1200 mm 47,2"
	1150 mm 45,3"	1300 mm 51,2"	1850 mm 72,8"	2200 mm 86,6"



[www.facebook.com/MONDOLFOFERROofficial](https://www.facebook.com/MONDOLFOFERROofficial)



<http://www.youtube.com/user/MondolfoFerro>



<https://www.instagram.com/mondolfoferro>

NEXION SPA  
info@mondolfoferro.it  
www.mondolfoferro.it





VULCANIZZATORI - VULCANIZERS



VASCHE PROVA CAMERE D'ARIA E TUBELESS - TANKS FOR TYRE TEST



	MT18	MT24S
	820 mm	1350 mm
	340 mm	500 mm
	1100*1100*1900 mm	1500*1500*1900 mm
	100 kg	280 kg



ISPEZIONATRICE - SPREADERS

	10" ÷ 17,5"
	700*570*1100 mm
	105 kg





# AUTOMOTIVE SERVICE EQUIPMENT



Sin dal 1963, anno di fondazione della nostra Azienda, abbiamo affidato all'immagine di un'aquila con le ali spiegate, il compito di rappresentare lo spirito più autentico e profondo della nostra filosofia imprenditoriale.

Oggi sappiamo di non esserci sbagliati.

Come l'aquila abbiamo volato molto in alto, forse più delle nostre stesse aspettative.

E questo grazie ad un incessante lavoro di perfezionamento tecnologico e professionale sempre accompagnato da una tenace volontà di innovazione.

Siamo altrettanto consapevoli che non saremmo mai arrivati tanto in alto senza il sostegno e la fiducia di tutti i nostri clienti e dei nostri partner che sentiamo particolarmente vicini.

Anche loro, come noi, (ognuno a proprio modo), hanno inseguito e realizzato un grande sogno "a quattro ruote".



Since 1963, the year in which our company was founded, we have used a spread eagle to represent the essence of our corporate philosophy.

Now we know that we made the right choice.

Just like the eagle, we too have soared to great heights, perhaps even surpassing our own expectations, thanks to our ongoing technological and professional perfection, inextricably matched with a determined desire for innovation.

We are just as aware that we could never have come so far without the support and trust of all our customers and partners, to whom we feel especially close.

They too, like us, (each in their own way), have followed and realized a great "four-wheel" dream.



[www.facebook.com/MONDOLFOFERROofficial](https://www.facebook.com/MONDOLFOFERROofficial)



<http://www.youtube.com/user/MondolfoFerro>



<https://www.instagram.com/mondolfoferro>

NEXION SPA  
info@mondolfoferro.it  
www.mondolfoferro.it

